

Model: IK-044 - INDUSTRIAL RANGE

400/230 V - THREE-PHASE | 1.500 R.P.M. | 50 Hz

Genset with manual control panel.



Image for guidance purposes.

PRP

CONTINUOUS POWER: 40 kVA

PRP "Prime Power" norma ISO 8528-1

LTP

STAND-BY POWER: 44 kVA

LTP "Limited Time Power" norma ISO 8528-1

ENGINE

MAKE	MODEL
KOHLER	KDI2504TM

ALTERNATOR

MAKE	MODEL
MECC-ALTE	ECP 32-3S / 4

VOLTAGE	HZ	PHASE	COS Ø	PRP kVA/kW	LTP kVA/kW	AMP. (LTP)
400/230	50	3	0,8	41,3/33,0	45,4/36,3	65,62

ELECTRO EXIM SRL

ELECTRO EXIM SRL
21 Ialomicioarei St., sector 1, code 011277, BUCHAREST - ROMANIA
Phone: 0040 21 2231347 - 0040 744 755 390 - FAX: 0040 21 2231201
E-mail: office@electroexim.com - Web: www.electroexim.ro

Model: IK-044 - INDUSTRIAL RANGE

400/230 V - THREE-PHASE | 1.500 R.P.M. | 50 Hz

ENGINE CHARACTERISTICS

MAKE	MODEL
KOHLER	KDI2504TM

General Data

Power PRP (kWm)	37.30
Power LTP (kWm)	41.00
No. cylinders	4
Cylinder capacity (L)	2.482
Diameter per stroke (mm)	88 x 102
Compression ratio	-
Cooling system	LIQUID
Injection	DIRECT
Suction	TURBO
Series regulator	MECHANICAL
Fly wheel coupling	3-11,5"

Lubrication system

Oil capacity (L)	11.50
Oil consumption (%)	0.10
Min. alarm oil pressure (bar)	-

Ventilation system

Air cooling flow (m ³ /h)	7200
Combustion air flow (m ³ /h)	212.00
Max. back pressure for fan (mbar)	-

Exhaust system

Exhaust gas flow (m ³ /h)	185
Exhaust back pressure (mbar)	80
Temp. exhaust gases (°C)	530

Electrical system

VDC (V)	12
Battery (Ah)	90
Engine start-up (kW)	-

Model: IK-044 - INDUSTRIAL RANGE

400/230 V - THREE-PHASE | 1.500 R.P.M. | 50 Hz

ALTERNATOR CHARACTERISTICS

MAKE	MODEL
MECC-ALTE	ECP 32-3S / 4

General Data

Power PRP (kVA)	42.50
Power LTP (kVA)	46.75
Efficiency Alt. 3/4 %	89.10
Efficiency Alt. 4/4 %	88.60
No. Poles	4
Voltage regulator	DSR
No. wires	12
Insulation	H
Xd (%)	190
X'd (%)	14.30
X	10
Degree of protection	IP23

GENERATOR SET CONSUMPTION

% POWER USED	LITRES/HOUR
50%	5.70
75%	8.00
100%	10.30

DIMENSIONS, CAPACITIES, APPROXIMATE WEIGHT

Dimensions (mm)		
LENGTH	WIDTH	HEIGHT

2500

1100

1455

FUEL TANK (LITRES)	WEIGHT (KG)
--------------------	-------------

85

1200

NOISE LEVEL (dB (A))

64 @ 7m

Model: IK-044 - INDUSTRIAL RANGE

400/230 V - THREE-PHASE | 1.500 R.P.M. | 50 Hz



INMESOL GENERATOR SET

GENERAL DESCRIPTION

The “INMESOL” generator set is an electrical energy generating machine which is used in places where there is **no mains supply** or when there is a MAINS failure.

The mobile elements, distribution belt, fan, etc., and those parts which reach high temperatures during operation, exhaust manifold, etc, include their corresponding protections, in compliance with the requirements of the Machinery Directive **2006/42**.

REGULATIONS

The machine holds the “CE” marking, and the corresponding Declaration of Conformity is issued with each of them, in which it specifies that the machine complies with **R.D 842/2002 Low Voltage Regulations and with the European Directives:**

- 2006/42 on Safety in Machinery.
- 2006/95/CE on Electrical Safety.
- 2004/108/CE on Electromagnetic Compatibility.
- 2005/88/CE on NOISE EMISSIONS by equipment for outdoor use (for SOUNDPROOF GENERATOR SETS).

Model: IK-044 - INDUSTRIAL RANGE

400/230 V - THREE-PHASE | 1.500 R.P.M. | 50 Hz

IN INDUSTRIAL
RANGE

Scope of supply



Engine/alternator monobloc directly connected and installed via silent blocks on a frame made from high tensile electro welded steel profiles that are treated with degreasing liquids and applied with a phosphate coat and polyester (QUALICOAT) paint.

Canopy of steel sheet sound proofed with fireproof rockwool, and treated with degreasing liquids and applied with a phosphate coat and polyester (QUALICOAT) paint.

Sealed chassis

Fuel tank integrated in the base frame provided with fuel level gauge and fuel connections to the engine.

Engine with mechanical engine driven pusher fan.

Residential silencer with -35 db(A) noise reduction with exhaust tube and protection cap.

Electric control cubicle with control module including protection and reading of electrical measures engine instrumentation fuel level and engine running hours, etc. remote start possibility

Thermal and magnetic circuit breaker and thermal and magnetic circuit breaker and earth fault relay.

Battery charge alternator.

Starter battery complete with cables to the engine and pole protection.

Installation prepared for earthing spike (spike not included).

Security protection for heat and moving parts as well as live electrical components.

External emergency stop push button.

Manual engine oil extraction pump.

Self excited and auto regulated alternator.

Integrated lifting hook for single point lifting with crane, gensets up to 450 kVA (Except in swing-out cover model)

Base frame is prepared for trailer kit installation.

Standard electronic speed governor on engines from 220 kVA (LTP) and up.

Horizontal outlet for hot air (till canopy 4200x1600x2245)

OPTIONS

Battery charger

Coolant preheating

AMF/ATS panel to turn a manual gen set to automatic version (consult the last page)

Integral additional socket panel from 20 kVA till 400 kVA PRP

Residential silencer

V1 PREWIRED VERSION
FOR AMF

V2 GENSETS WITH AMF/ATS PANEL
AND 4 POLE CIRCUIT BREAKER

V3 GENSET WITH AMF CONTROL PANEL BUT WITHOUT ATS PANEL
AND SEPARATED ATS PANEL

ELECTRO EXIM SRL

ELECTRO EXIM SRL
21 Ialomicioarei St., sector 1, code 011277, BUCHAREST - ROMANIA
Phone: 0040 21 2231347 - 0040 744 755 390 - FAX: 0040 21 2231201
E-mail: office@electroexim.com - Web: www.electroexim.ro

Model: IK-044 - INDUSTRIAL RANGE

400/230 V - THREE-PHASE | 1.500 R.P.M. | 50 Hz

DSE 3110 MANUAL CONTROL PANEL

MANUAL CONTROL, PROTECTION AND DISTRIBUTION panel, assembled on the generator set in metal cabinet with a DSE 3110 engine protection unit.

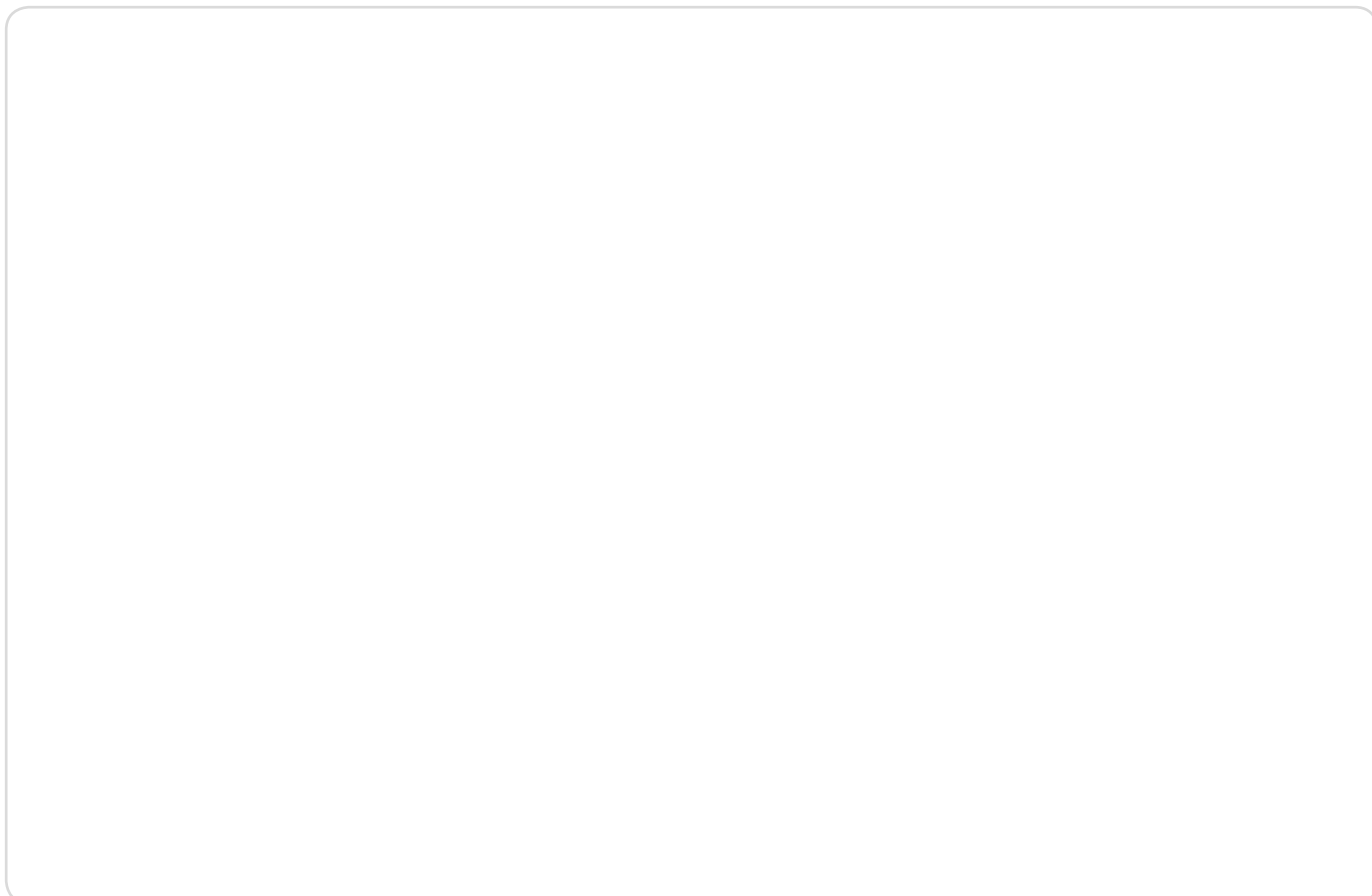

Image for guidance purposes.

It has the following:

1. STARTER SWITCH

2. EMERGENCY STOP PUSHBUTTON

3. MEASURING INSTRUMENTS:

Analogue(s) ammeter(s)

Fuel level indicator.

Analogue voltmeter

Digital Hz display and hour meter (DSE 3110)

Model: IK-044 - INDUSTRIAL RANGE 400/230 V - THREE-PHASE | 1.500 R.P.M. | 50 Hz

DSE 3110 MANUAL CONTROL PANEL

4. SET CONTROL AND ENGINE PROTECTION: DSE 3110, allows:

START AND STOP the set MANUALLY.

Possibility of doing it AUTOMATICALLY via START ON SIGNAL

Digital readings of the operating hours and the Frequency

Controls the main characteristics of the engine, causing an alarm or stopping the machine:

- Low and High Voltage (STOP)
- Low and High Frequency and Speed (STOP)
- Low Oil Pressure and High Coolant Temperature (STOP)
- Failure of the Alternator Battery-Charger (ALARM)
- Low fuel level (ALARM)

5. PROTECTIONS

MAGNETO. PROTECTION (A)	EARTH LEAK PROTECTION	DISTRIBUTION
63A, 4P	Modular 63A, 30mA	CEE5P63A+CEE5P16A+Sc huko

OPTIONS

OPTIONAL 1:

AUTOMATIC PANEL FOR MANUAL GENERATOR: ATS DSE 334

This panel provides the manual control generator with a reserve operation from the Mains, as the ATS sends the command to start and stop the generator. when it detects a supply failure and when the Mains is restored.



Image for guidance purposes.

It has the following:

Change over switch made up of two contactors with mechanical and electrical latching.

Battery charger

Fuses

Mains and group input and charge output connection terminal block.

DSE 334 Automatic Transfer Control Module, providing the following functions and features:

- Output to voltage free relay.
- Automatic supply failover.
- Real time clock
- 10 inputs and 5 outputs can be customised
- Events log
- Customisable timers
- Setup can be completed through PC and/ or through the panel itself.
- LED indicators.
- Four-line screen
- Input for generator set failure.
- Electric current monitoring (optional)
- Voltage levels can be adjusted to mains failure
- Generator availability indicator.
- Start signal to the engine

Model: IK-044 - INDUSTRIAL RANGE

400/230 V - THREE-PHASE | 1.500 R.P.M. | 50 Hz

OPTIONS

OPTION 2:

FAILOVER TO DSE 6010 MKII MANUAL DIGITAL CONTROL MODULE

LCD SCREEN:

It has a digital LCD screen, which provides easy reading of the information regarding the ENGINE, ALTERNATOR and CHARGING.

ENGINE:

Coolant temperature

Oil pressure

Turning speed (rpm)

Fuel level

Battery voltage

Battery alternator voltage

Operating hours

Number of start-ups

ALTERNATOR AND CHARGE:

Voltages between phases and between phases and neutral.

Intensities

Frequency

CONTROL OF THE SET:

START AND STOP the set MANUALLY.

Possibility of doing it AUTOMATICALLY via START ON SIGNAL.

PROTECTION OF THE ENGINE AND ALTERNATOR, WITH THE ALARMS ACTIVATED:

ENGINE:

Low oil pressure

High coolant temperature

Low and High battery Voltage.

Failure of the alternator to charge batteries

Low fuel level..

ALTERNATOR:

Low and High Voltage

Low and High Frequency

Overload due to Intensity (A)

OTHER CHARACTERISTICS:

The real-time clock records the last 50 events.s.

Configurable inputs and outputs.

Configurable alarms and timers.

USB connectivity

Fully configurable via software and PC.

Communication via USB cable for remote control

Programmable clock with multiple maintenance events which can be configured for optimal motor functioning. Weekly and/or monthly programming for up to 8 startups and shutdowns per week.

ALTERNATIVE CONFIGURATIONS, which open up the working possibilities.

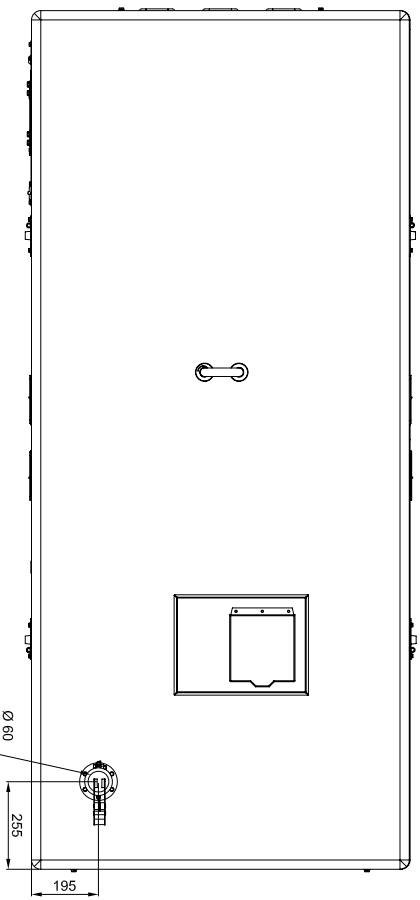
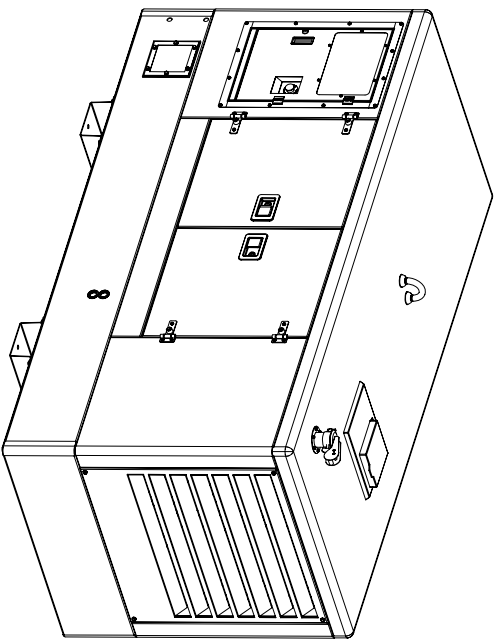
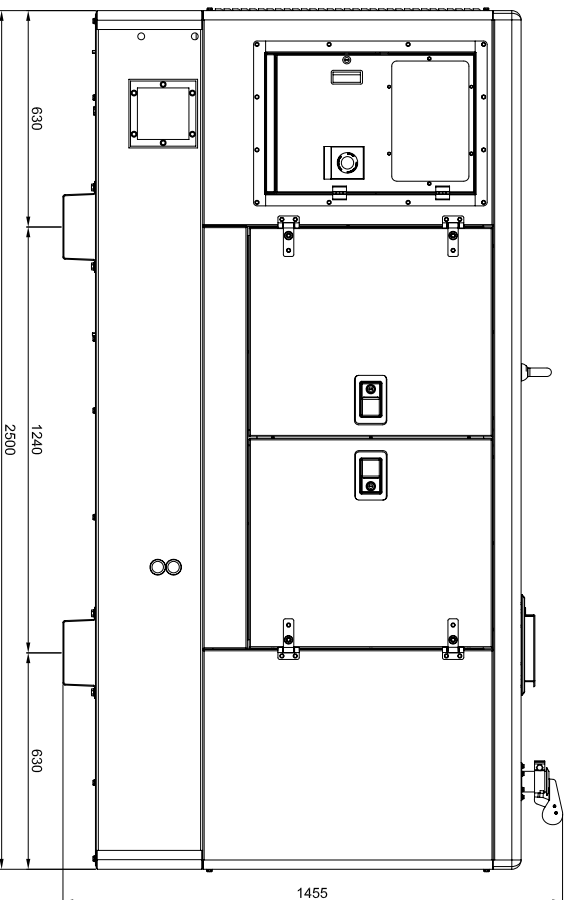
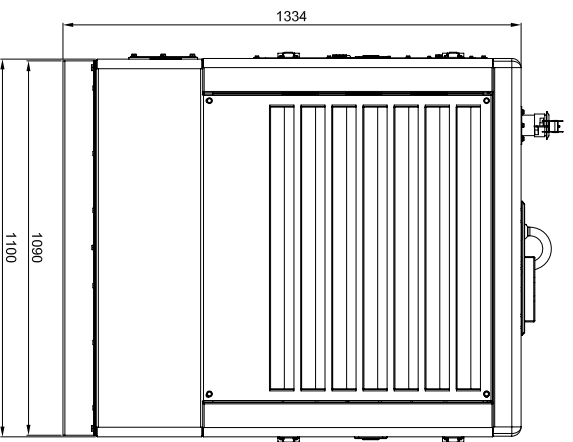

CAPACIDAD DE DEPOSITO = 85 LTS

		PROYECTO:		
		G.E. INSONORO 40-60 Kva R12		
UN Intendencia o cumplir en apariencia de una, a fin de	MODIFICADO	J.G.BEABAR	23/10/2012	MATERIAL
Todo personal, o al menos el encargado del servicio	DIBUJADO	J.G.BEABAR	24/Feb/11	TOLERANCIA GENERAL
Indicando se incluye en el presupuesto el material que	COMPROBADO	J.L.SOLANO	23/10/2012	UDS.
se indica en el presupuesto de cada ítem.	CONIGO			mm
ESCALA	PESO	DENOMINACION:		EXEQUENTE:
		G.E. INSONORO 40-60 Kva R12		Nº MOD
		DIMENSIONES GENERALES		Nº PLANO
				MARCA

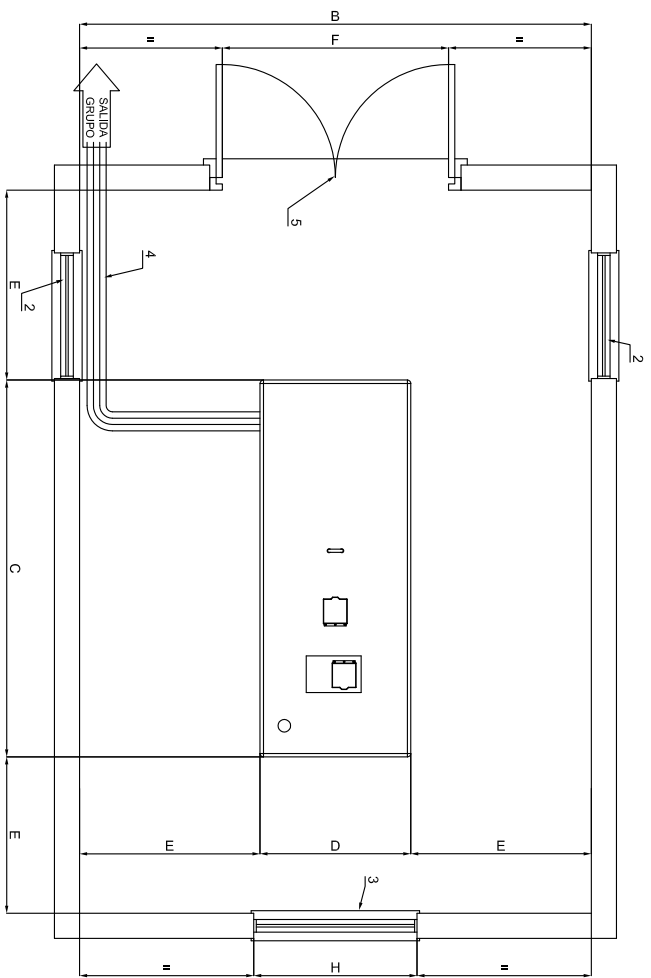
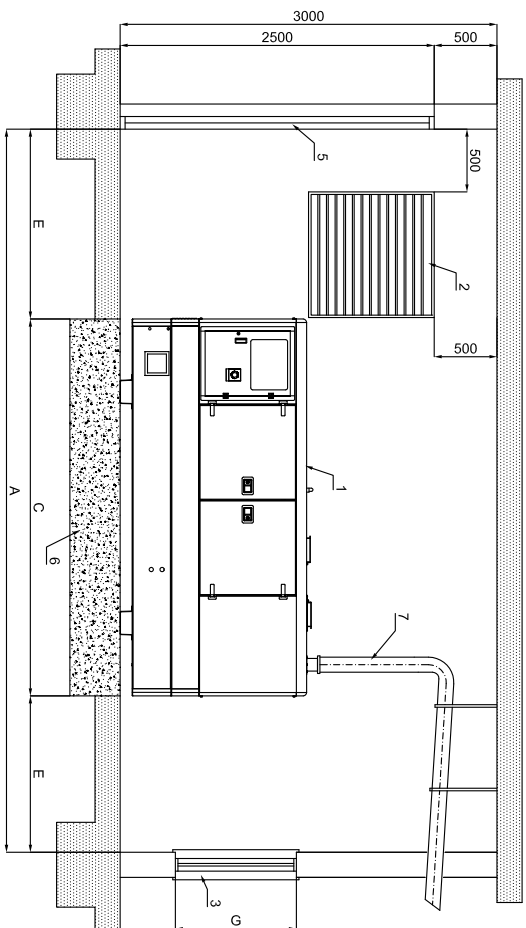

DIMENSIONES MINIMAS DE SALA SEGUN POTENCIA										
POTENCIA (Kva)	A	B	C	D	E	F	G	H	I	PESO
8-15 ABATIBLE										SECCION HUECO ENTRADA AIRE
10-15										2x0.50 m ²
20-30										2x0.50 m ²
40-60-75										2x0.90 m ²
85-105-130										2x1.00 m ²
150-180-200-250										2x2.50 m ²
										2x3.00 m ²
										2x3.50 m ²

- NOMENCLATURA**
- 1.- GRUPO ELECTROGENO
 - 2.- HUECO ENTRADA DEL AIRE
 - 3.- TUNEL EXPULSION DEL AIRE
 - 4.- BANDEJA PASACABLES
 - 5.- PUERTA DE ACCESO
 - 6.- BASE HORMIGON ARMADO H-175
 - 7.- TUBO DE ESCAPE

CALCULO ESPESOR LOSA DE HORMIGON

$$E = \frac{W}{d \times D \times C}$$

E = altura bloque de hormigon
 W = peso total grupo electrogeno
 d = densidad del hormigon (2400 kg/m³)
 D = anchura bloque de hormigon (m)
 C = longitud bloque de hormigon (m)

EL Ø DE LA TUBERIA DE EXTENSION DEL ESCAPE PUEDE SER EL MISMO QUE EL DEL SILENCIADOR HASTA 5 m. PARA DISTANCAS MAYORES DE 5 m. DEBE AUMENTARSE EL Ø DE LA TUBERIA 10 mm POR CADA 10 m MAS DE DISTANCIA ENTRE EL GRUPO ELECTROGENO Y LA SALIDA EXTERIOR

Una vez obtenida la licencia de apertura de la obra, el contratista deberá presentar a la autoridad competente el proyecto de obra, el cual deberá estar debidamente autorizado y validado, con la correspondencia que se indica a continuación.										
CODIGO	PROYECTO:	MODIFICADO	AGUILAR	02-Ene-2015	MATERIAL					
PESO		DIBUJADO	J.GEBELAR	27-Feb-2008	TOLENCIA GENERAL					
ESCALA		CONPROBADO	J.L.SOLANO	04-Oct-2012	UDS.					
		DENOMINACION:	GRUPO INSONORIZADO		EXPEDIENTE:					
			DIMENSIONES DE SALA		Nº PLANO					
					MARCA					

GRUPO INSONORIZADO