

Model: IK-022 - STAND-BY RANGE

400/230 V - THREE-PHASE | 1.500 R.P.M. | 50 Hz

Automatic with amf/ats panel Stand-by Genset V2.



Image for guidance purposes.

## PRP

**CONTINUOUS POWER:** 20 kVA

PRP "Prime Power" norma ISO 8528-1

## LTP

**STAND-BY POWER:** 22 kVA

LTP "Limited Time Power" norma ISO 8528-1

## ENGINE

MAKE	MODEL
KOHLER	KDI1903M

## ALTERNATOR

MAKE	MODEL
MECC-ALTE	ECP 28-M/4

VOLTAGE	HZ	PHASE	COS Ø	PRP kVA/kW	LTP kVA/kW	AMP. (LTP)
400/230	50	3	0,8	18,9/15,2	20,8/16,6	30,07

**ELECTRO EXIM SRL**

**ELECTRO EXIM SRL**  
21 Ialomicioarei St., sector 1, code 011277, BUCHAREST - ROMANIA  
Phone: 0040 21 2231347 - 0040 744 755 390 - FAX: 0040 21 2231201  
E-mail: office@electroexim.com - Web: www.electroexim.ro

Model: IK-022 - STAND-BY RANGE

400/230 V - THREE-PHASE | 1.500 R.P.M. | 50 Hz

## ENGINE CHARACTERISTICS

MAKE	MODEL
KOHLER	KDI1903M

### General Data

Power PRP (kWm)	17.30
Power LTP (kWm)	19.00
No. cylinders	3
Cylinder capacity (L)	1.861
Diameter per stroke (mm)	88 x 102
Compression ratio	-
Cooling system	LIQUID
Injection	DIRECT
Suction	NATURAL
Series regulator	MECHANICAL
Fly wheel coupling	4 - 7,5"

### Lubrication system

Oil capacity (L)	8.90
Oil consumption (%)	0.10
Min. alarm oil pressure (bar)	-

### Ventilation system

Air cooling flow (m <sup>3</sup> /h)	1700
Combustion air flow (m <sup>3</sup> /h)	98.40
Max. back pressure for fan (mbar)	-

### Exhaust system

Exhaust gas flow (m <sup>3</sup> /h)	-
Exhaust back pressure (mbar)	50
Temp. exhaust gases (°C)	540

### Electrical system

VDC (V)	12
Battery (Ah)	60
Engine start-up (kW)	-



Model: IK-022 - STAND-BY RANGE

400/230 V - THREE-PHASE | 1.500 R.P.M. | 50 Hz



## INMESOL GENERATOR SET

### GENERAL DESCRIPTION

The “INMESOL” generator set is an electrical energy generating machine which is used in places where there is **no mains supply** or when there is a MAINS failure.

The mobile elements, distribution belt, fan, etc., and those parts which reach high temperatures during operation, exhaust manifold, etc, include their corresponding protections, in compliance with the requirements of the Machinery Directive **2006/42**.

### REGULATIONS

The machine holds the “CE” marking, and the corresponding Declaration of Conformity is issued with each of them, in which it specifies that the machine complies with **R.D 842/2002 Low Voltage Regulations and with the European Directives:**

- 2006/42 on Safety in Machinery.
- 2006/95/CE on Electrical Safety.
- 2004/108/CE on Electromagnetic Compatibility.
- 2005/88/CE on NOISE EMISSIONS by equipment for outdoor use (for SOUNDPROOF GENERATOR SETS).

Model: IK-022 - STAND-BY RANGE

400/230 V - THREE-PHASE | 1.500 R.P.M. | 50 Hz

**SB** **STAND-BY**  
RANGE

**Scope of supply**

**V2** **Gensets WITH AMF/ATS PANEL and 4 Pole Circuit Breaker**

**V2**



Engine/alternator monobloc directly connected and installed via silent blocks on a frame made from high tensile electro welded steel profiles that are treated with degreasing liquids and applied with a phosphate coat and Polyester (QUALICOAT) paint.	External emergency stop push button.
Canopy of steel sheet sound proofed with fireproof rockwool, and treated with degreasing liquids and applied with a phosphate coat and Polyester (QUALICOAT) paint.	Manual engine oil extraction pump.
Sealed chassis	Self excited and auto regulated alternator.
Fuel tank integrated in the chassis provided with fuel level gauge and fuel lines to the engine.	Integrated lifting hook for single point lifting with crane, gensets up to 450 kVA (Except in swing-out cover mode)
Engine with mechanical engine driven pusher fan.	Base frame prepared for trailer kit
Residential silencer with -35 db(a) noise reduction with exhaust tube and protection cap.	Standard electronic speed governor on engines from 220 kVA and up.
Thermal and magnetic circuit breaker	Electric control cubicle with digital control module, automatic mains failure, manual start or remote start on signal with change over switch in the same cabinet.
Battery charge alternator.	Battery charger for gen set with 12VCC battery (2A).
Starter battery complete with cables to the engine and pole protection.	Battery charger for gen set with 24VCC battery (5A).
Installation prepared for earthing spike (spike not included).	Electric engine coolant preheating on gen sets with automatic mains failure controller.
Security protection for belts and moving parts as well as on electrical component.	Horizontal outlet for hot air (till canopy 4200x1600x2245)
	Control cable of 6 m

**OPTIONS**

Earth fault relay
Integral additional socket panel (from 20 kVA till 400 kVA PRP)
Residential silencer

**V1** PREWIRED VERSION FOR AMF

**V2** GENSETS WITH AMF/ATS PANEL AND 4 POLE CIRCUIT BREAKER

**V3** GENSET WITH AMF CONTROL PANEL BUT WITHOUT ATS PANEL AND SEPARATED ATS PANEL

**ELECTRO EXIM SRL**

**ELECTRO EXIM SRL**  
21 Ialomicioarei St., sector 1, code 011277, BUCHAREST - ROMANIA  
Phone: 0040 21 2231347 - 0040 744 755 390 - FAX: 0040 21 2231201  
E-mail: office@electroexim.com - Web: www.electroexim.ro

Model: IK-022 - STAND-BY RANGE

400/230 V - THREE-PHASE | 1.500 R.P.M. | 50 Hz

**DSE 6020 MKII AUTOMATIC CONTROL PANEL WITH AMF/ATS PANEL**

**V2**

PROTECTION, DISTRIBUTION AND AUTOMATIC CONTROL panel which starts the generator set when it detects a mains failure and stops it when the mains is restored with the control unit DSE 6020 MKII. It also starts and stops the group manually via a pushbutton or remote start-up by contact. It incorporates change over switch. The entire assembly is in a steel enclosure separated from the gen set.



Image for guidance purposes.

It has the following:

## 1. EMERGENCY STOP PUSHBUTTON

## 2. PROTECTIONS:

Magnetothermal switch (preheating resist.) 2P (16 A)

Protection fuses for control module

## 3. BATTERY CHARGER

**V1** PREWIRED VERSION FOR AMF

**V2** GENSETS WITH AMF/ATS PANEL AND 4 POLE CIRCUIT BREAKER

**V3** GENSET WITH AMF CONTROL PANEL BUT WITHOUT ATS PANEL AND SEPARATED ATS PANEL

**ELECTRO EXIM SRL**

**ELECTRO EXIM SRL**  
21 Ialomicioarei St., sector 1, code 011277, BUCHAREST - ROMANIA  
Phone: 0040 21 2231347 - 0040 744 755 390 - FAX: 0040 21 2231201  
E-mail: office@electroexim.com - Web: www.electroexim.ro

Model: IK-022 - STAND-BY RANGE

400/230 V - THREE-PHASE | 1.500 R.P.M. | 50 Hz

**DSE 6020 MKII AUTOMATIC CONTROL PANEL WITH AMF/ATS PANEL**

**V2**

## 4. DSE 6020 MKII PROTECTION CONTROL MODULE.

### LCD SCREEN:

It has a digital LCD screen, which provides easy reading of the information regarding the ENGINE, ALTERNATOR, MAINS and CHARGING.

ENGINE:	ALTERNATOR AND CHARGE:	MAINS:
Coolant temperature	Voltages between phases and between phases and neutral.	Frequency
Oil pressure	Intensities	Voltages between phases and neutral (L1-N, L2-N, L3-N).
Turning speed (rpm)	Frequency	Voltages between phases and (L1-L2, L2-L3, L1-L3).
Fuel level	Active Power (kW)	Active Power (kW)
Battery voltage	Reactive Power (kVAr)	Reactive Power (kVAr)
Battery alternator voltage.	Apparent Power (kVA)	Apparent Power (kVA)
Operating hours	Cos phi	Cos phi
Number of start-ups	Active energy meter (kW-h)	

### CONTROL OF THE SET:

STARTS and STOPS the set AUTOMATICALLY when mains failure is detected and when it is restored, respectively.

It can also operate MANUALLY a REMOTE STAR.

Breaker control via fascia buttons.

### PROTECTION OF THE ENGINE AND ALTERNATOR, WITH THE ALARMS ACTIVATED:

ENGINE:	ALTERNATOR:	MAINS:
Low oil pressure	Low and High Voltage	Low and High Voltage
High coolant temperature	Low and High Frequency	Low and High Frequency
Low and High battery Voltage.	Overload due to Intensity (A)	
Failure of the alternator to charge batteries	Power Overload (KW)	
Low fuel level		
Engine maintenance alarms for fuel filter, air filter and oil filter		

### OTHER CHARACTERISTICS:

The real-time clock provides an exact record of events.	USB connectivity	Programmable clock with multiple maintenance events which can be configured for optimal motor functioning. Weekly and/or monthly programming for up to 8 startups and shutdowns per week.
Extensive number of configurable inputs and outputs.	Fully configurable via software and PC.	ALTERNATIVE CONFIGURATIONS, which open up the working possibilities
Configurable alarms and timers.	Communication via USB cable for remote control	

**V1** PREWIRED VERSION FOR AMF

**V2** GENSETS WITH AMF/ATS PANEL AND 4 POLE CIRCUIT BREAKER

**V3** GENSET WITH AMF CONTROL PANEL BUT WITHOUT ATS PANEL AND SEPARATED ATS PANEL

**ELECTRO EXIM SRL**

**ELECTRO EXIM SRL**  
21 Ialomicioarei St., sector 1, code 011277, BUCHAREST - ROMANIA  
Phone: 0040 21 2231347 - 0040 744 755 390 - FAX: 0040 21 2231201  
E-mail: office@electroexim.com - Web: www.electroexim.ro

Model: IK-022 - STAND-BY RANGE

400/230 V - THREE-PHASE | 1.500 R.P.M. | 50 Hz

**DSE 6020 MKII AUTOMATIC CONTROL PANEL WITH AMF/ATS PANEL**

**V2**

## 5. PROTECTIONS

MAGNETO. PROTECTION (A)	EARTH LEAK PROTECTION	DISTRIBUTION	AMF/ATS PANEL
32A, 4P	Opcional	Direct from circuit breaker	30

**V1** PREWIRED VERSION FOR AMF

**V2** GENSETS WITH AMF/ATS PANEL AND 4 POLE CIRCUIT BREAKER

**V3** GENSET WITH AMF CONTROL PANEL BUT WITHOUT ATS PANEL AND SEPARATED ATS PANEL

**ELECTRO EXIM SRL**

**ELECTRO EXIM SRL**  
 21 Ialomicioarei St., sector 1, code 011277, BUCHAREST - ROMANIA  
 Phone: 0040 21 2231347 - 0040 744 755 390 - FAX: 0040 21 2231201  
 E-mail: office@electroexim.com - Web: www.electroexim.ro



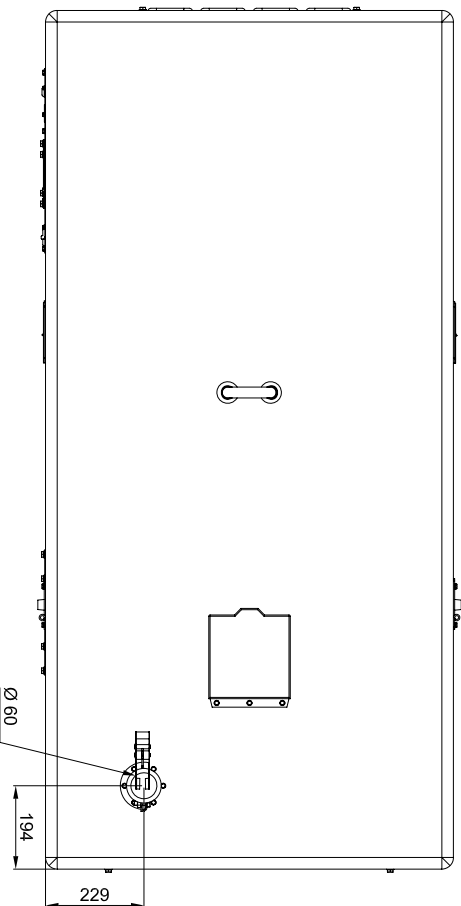
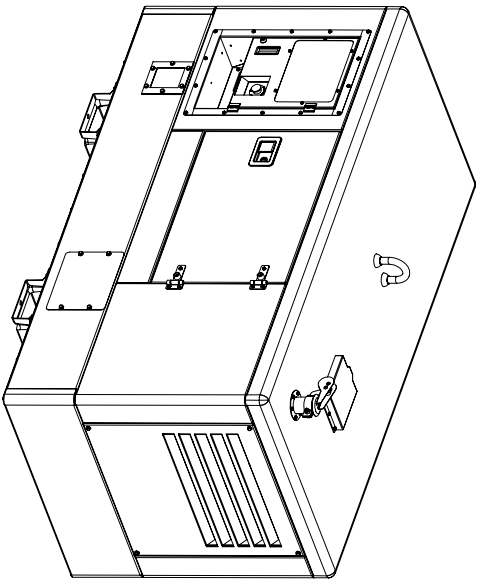
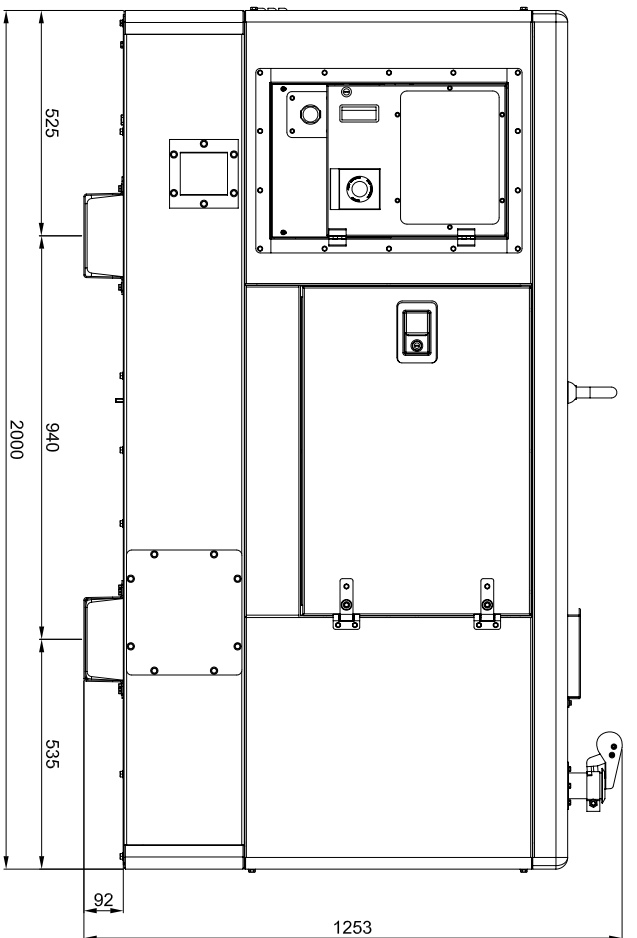
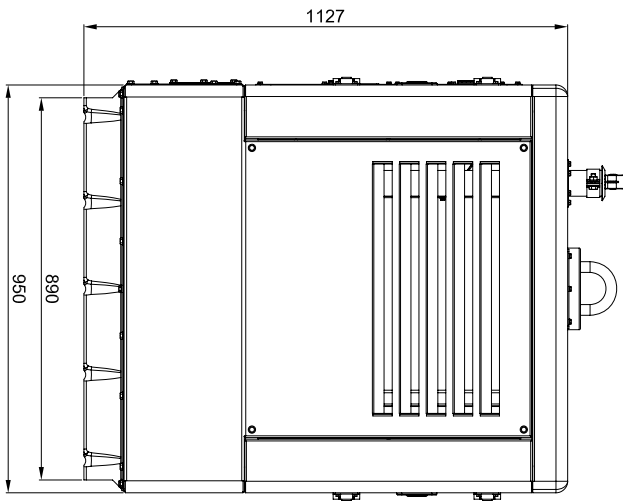

CAPACIDAD DE DEPOSITO = 85 LTS

		<b>PROYECTO:</b>	
Las tolerancias o límites de espesores de origen, a de fabrica, se aplican a los productos que se detallan en el presente catálogo, a menos que se indique lo contrario. Las tolerancias de fabricación de los productos se aplican a los productos que se detallan en el presente catálogo, a menos que se indique lo contrario. Las tolerancias de fabricación de los productos se aplican a los productos que se detallan en el presente catálogo, a menos que se indique lo contrario.		<b>G.E. INSONORO 20-30 Kva R12</b>	
MODIFICADO	J.S.BELAR	08-MAR-2012	MATERIAL
DIBUJADO	J.S.BELAR	08-MAR-2012	TOLERANCIA GENERAL
COMPROBADO	A.L.SOLANO	08-MAR-2012	UDS.
CODIGO			EXPEDIENTE:
REPO			Nº MOD.
ESCALA			Nº PLANO
			MARCA

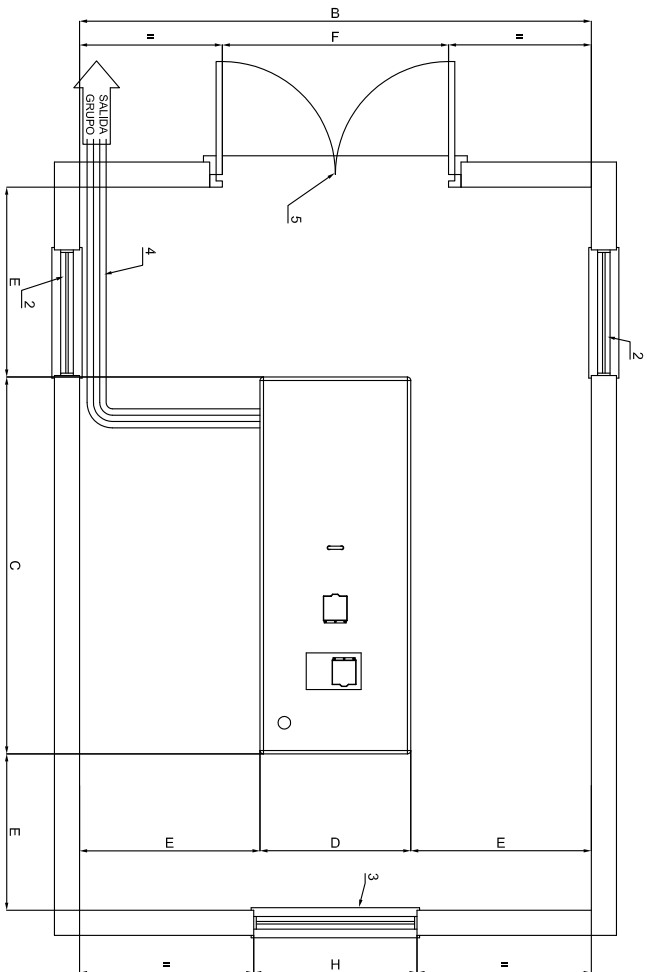
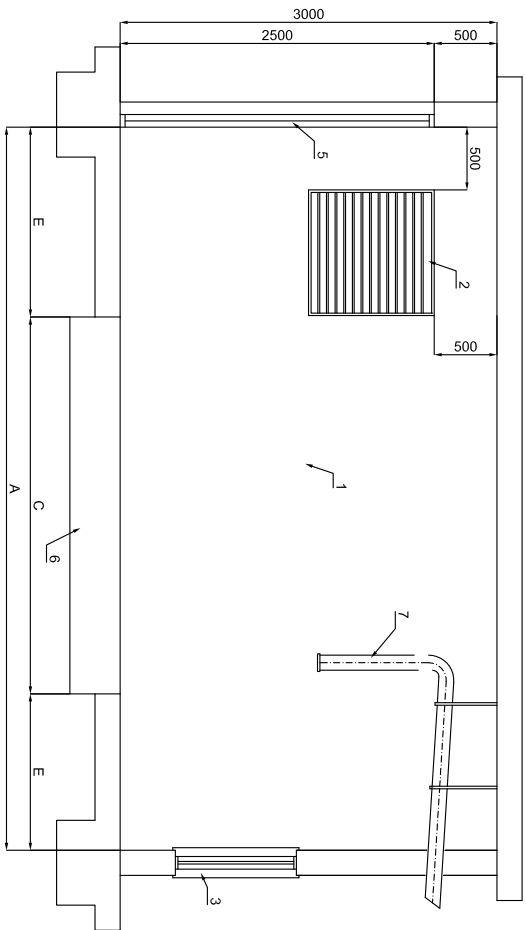

**NOMENCLATURA**

- 1.- GRUPO ELECTROGENO
- 2.- HUECO ENTRADA DEL AIRE
- 3.- TUNEL EXPULSION DEL AIRE
- 4.- BANDEJA PASACABLES
- 5.- PUERTA DE ACCESO
- 6.- BASE HORMIGON ARMADO H-175
- 7.- TUBO DE ESCAPE

**CALCULO ESPESOR LOSA DE HORMIGON**

$$E = \frac{W}{d \times D \times C}$$

E = altura bloque de hormigon  
W = peso total grupo electrogeno  
d = densidad del hormigon (2400 kg/m<sup>3</sup>)  
D = anchura bloque de hormigon (m)  
C = longitud bloque de hormigon (m)

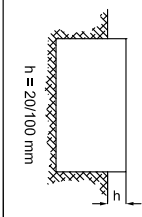

EL Ø DE LA TUBERIA DE EXTENSION DEL ESCAPE PUEDE SER EL MISMO QUE EL DEL SILENCIADOR HASTA 5 m. PARA DISTANCAS MAYORES DE 5 m. DEBE AUMENTARSE EL Ø DE LA TUBERIA 10 mm POR CADA 10 m MAS DE DISTANCIA ENTRE EL GRUPO ELECTROGENO Y LA SALIDA EXTERIOR

**GRUPO INSONORIZADO**

PROYECTO:		MODIFICADO		DIBUJADO		COMPROBADO		DENOMINACION:	
ESCALA		AGUILAR		J.GEBELAR		J.L.SOLANO		GRUPO INSONORIZADO DIMENSIONES DE SALA	
PESO		02-Ene-2015		27-Feb-2008		04-Oct-2012		MATERIAL TOLERANCIA GENERAL	
ESCALA		U.S.		EXPEDIENTE:		Nº PLANO		MARCA	

Una vez generada la versión de aprobación, el cliente debe firmar y sellar el documento. No se permite, ni se podrá admitir, el uso de copias o versiones no autorizadas. Toda reproducción o modificación de este documento sin el consentimiento escrito de la empresa será considerada una infracción de los derechos de propiedad intelectual.